

linea xs hp
pureWhite | pureColor



USER MANUAL



BEDIENUNGSANLEITUNG

USER MANUAL

linea xs hp pureWhite | pureColor

Safety Instructions



Devices must be installed by qualified personnel in compliance with all pertaining regulations.

For your own safety, read all instructions and mounting steps carefully.
Keep the instructions for maintenance or disassembly work.

The electrical connection may only be carried out by for this purpose trained and authorized personnel.

WARNING - Risk of electric shock!
Operate the lamp only with an undamaged cover plate.

The light source (LED module) of this light is not replaceable.

- When the light source reaches its end of life, replace the entire fixture.
- LED module: Risk group 1



Scope of delivery



- Check completeness of supplied device immediately after receipt.





In delivery included:

1x Luminaire according to specification product code
1x User manual

If you detect any transportation damage or differences between specified packing contents and your unpacked delivery, please contact your dealer immediately.

Technical Data

Dimensions	46 mm x 57 mm [W x H] 1.80 in x 2.25 in [W x H]														
Standard Unit Lengths	324 mm, 477 mm, 629 mm, 782 mm, 934 mm, 1087 mm, 1239 mm 12.76 in, 18.78 in, 24.77 in, 30.79 in, 36.78 in, 42.80 in, 48.78 in														
Fixture Typ	  pureWhite pureColor														
Color Temperatures pureWhite	2200 K, 2700 K, 3000 K, 3500 K, 4000 K * Project-specific color temperature for pureWhite available.														
LED-Colors pureColor	Red, Green, Blue, Amber * Project-specific colors for pureColor available.														
Beam Angles	8°, 10°, 23°, 43°, 8° x 31° 10° x 42°, 12° x 60°, 14° x 100°, 30° x 60°, 60° x 30°														
Luminous Flux	<table border="0"> <tr> <td>324 mm (12.76 in):</td> <td>876 lm</td> </tr> <tr> <td>477 mm (18.78 in):</td> <td>1314 lm</td> </tr> <tr> <td>629 mm (24.77 in):</td> <td>1752 lm</td> </tr> <tr> <td>782 mm (30.79 in):</td> <td>2190 lm</td> </tr> <tr> <td>934 mm (36.78 in):</td> <td>2628 lm</td> </tr> <tr> <td>1087 mm (42.8 in):</td> <td>3066 lm</td> </tr> <tr> <td>1239 mm (48.78 in):</td> <td>3504 lm</td> </tr> </table> pureColor red -> 406 lm/ft pureColor green -> 743 lm/ft pureColor blue -> 329 lm/ft pureColor amber -> 406 lm/ft	324 mm (12.76 in):	876 lm	477 mm (18.78 in):	1314 lm	629 mm (24.77 in):	1752 lm	782 mm (30.79 in):	2190 lm	934 mm (36.78 in):	2628 lm	1087 mm (42.8 in):	3066 lm	1239 mm (48.78 in):	3504 lm
324 mm (12.76 in):	876 lm														
477 mm (18.78 in):	1314 lm														
629 mm (24.77 in):	1752 lm														
782 mm (30.79 in):	2190 lm														
934 mm (36.78 in):	2628 lm														
1087 mm (42.8 in):	3066 lm														
1239 mm (48.78 in):	3504 lm														
Light Source	<table border="0"> <tr> <td>324 mm (12.76 in):</td> <td>8 LEDs</td> </tr> <tr> <td>477 mm (18.78 in):</td> <td>12 LEDs</td> </tr> <tr> <td>629 mm (24.77 in):</td> <td>16 LEDs</td> </tr> <tr> <td>782 mm (30.79 in):</td> <td>20 LEDs</td> </tr> <tr> <td>934 mm (36.78 in):</td> <td>24 LEDs</td> </tr> <tr> <td>1087 mm (42.8 in):</td> <td>28 LEDs</td> </tr> <tr> <td>1239 mm (48.78 in):</td> <td>32 LEDs</td> </tr> </table>	324 mm (12.76 in):	8 LEDs	477 mm (18.78 in):	12 LEDs	629 mm (24.77 in):	16 LEDs	782 mm (30.79 in):	20 LEDs	934 mm (36.78 in):	24 LEDs	1087 mm (42.8 in):	28 LEDs	1239 mm (48.78 in):	32 LEDs
324 mm (12.76 in):	8 LEDs														
477 mm (18.78 in):	12 LEDs														
629 mm (24.77 in):	16 LEDs														
782 mm (30.79 in):	20 LEDs														
934 mm (36.78 in):	24 LEDs														
1087 mm (42.8 in):	28 LEDs														
1239 mm (48.78 in):	32 LEDs														
Color Rendering Index	R _a >= 80														
Antiglare	optional: <ul style="list-style-type: none"> ▪ Hex louver (internal) ▪ Linear louver (internal) 														
LED-Binning															
MacAdam Ellipses Binning	3														
Dimming	Non-dimmable Dimmable (DALI , 0 - 10 V , DMX , EXT)														

Input Voltage	Power supply: external 36 VDC		
Power Consumption	324 mm (12.76 in):	Max. 14 W	
	477 mm (18.78 in):	Max. 21 W	
	629 mm (24.77 in):	Max. 28 W	
	782 mm (30.79 in):	Max. 35 W	
	934 mm (36.78 in):	Max. 42 W	
	1087 mm (42.8 in):	Max. 49 W	
	1239 mm (48.78 in):	Max. 56 W	
Protection Class	II		
Storage Temperatur	-40 °C / +80 °C -40 °F / +176 °F		
Operating Temperature	-40 °C / +40 °C -40 °F / +104 °F		
Start-up Temperature	-25 °C / +40 °C -13 °F / +104 °F		
Lumen Maintenance [L70]	65'000 h @ 25 °C (77 °F) 40'000 h @ 40 °C (104 °F)		
Housing	Aluminum extruded profile		
Housing Color(s)			
	Aluminium anodized (Standard)	Black anodized	
Lens	Tempered safety glass, extra white		
Weight	324 mm (12.76 in):	1,5 kg (3.31 lbs)	
	629 mm (24.77 in):	2,1 kg (4.63 lbs)	
	934 mm (36.78 in):	3,2 kg (7.05 lbs)	
	1239 mm (48.78 in):	4,4 kg (9.70 lbs)	
Ingress Protection	IP66		
Environment			
	indoor	outdoor	
Impact Protection	IK08		
Certification			

Engineering Drawing

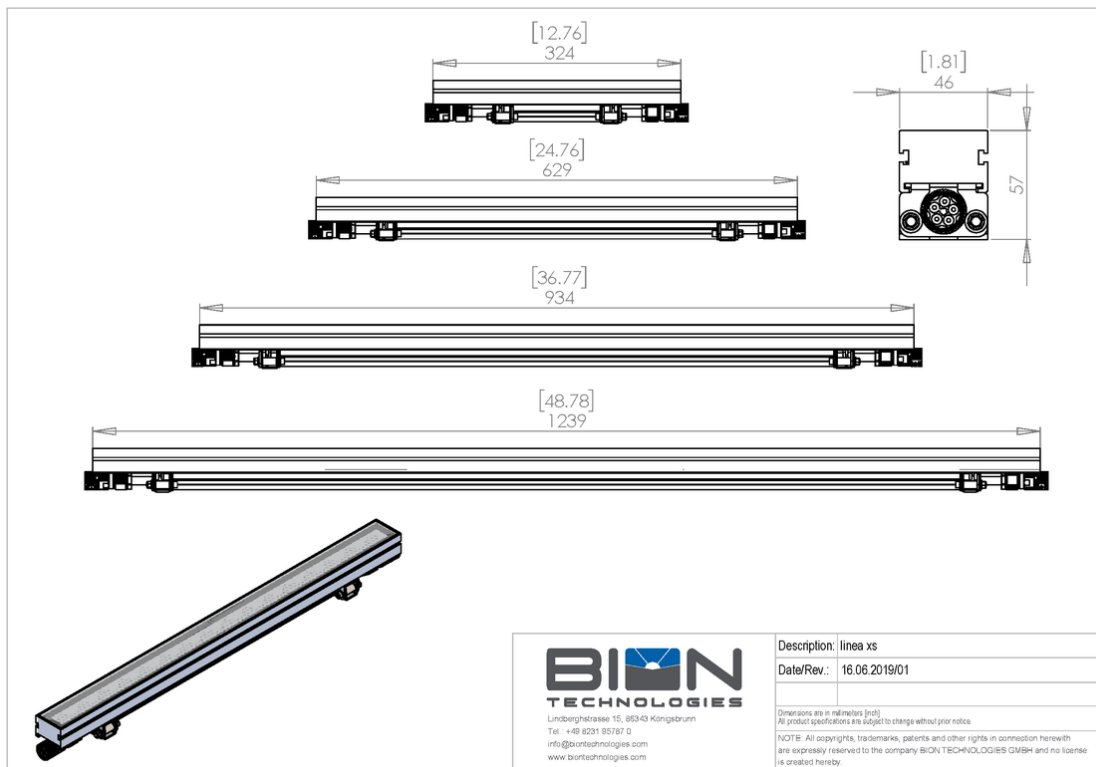

 Linderbergstrasse 15, 86343 Königsbrunn Tel.: +49 8231 95787 0 info@biontechnologies.com www.biontechnologies.com	Description: linea xs
	Date/Rev.: 16.06.2019/01
Dimensions are in millimeters [mm] All product specifications are subject to change without prior notice. NOTE: All copyrights, trademarks, patents and other rights in connection herewith are expressly reserved to the company BION TECHNOLOGIES GMBH and no license is created hereby.	

Commissioning

1. Electrical connection - DALI / DMX / 0-10 V

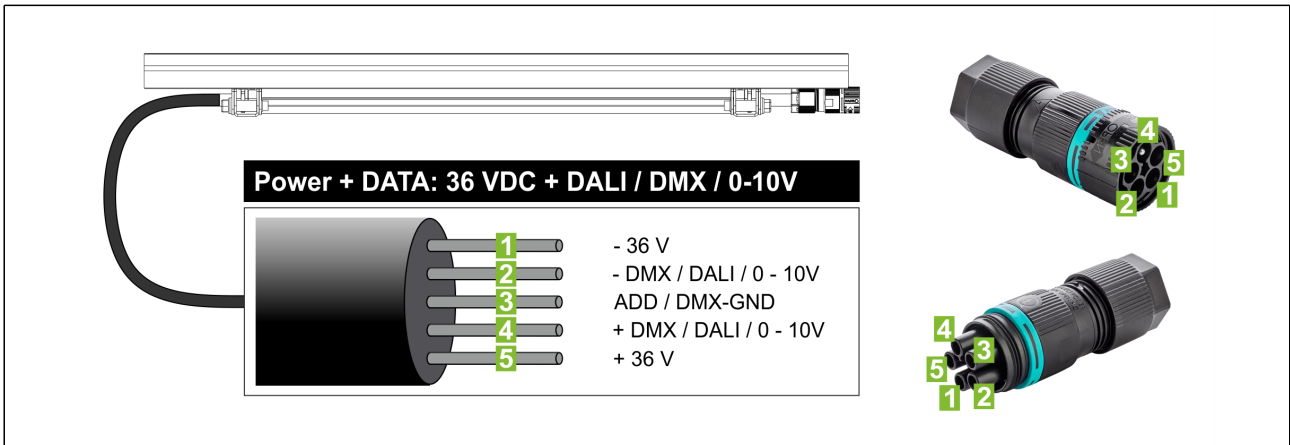

2. Electrical connection - EXT (Constant Current)

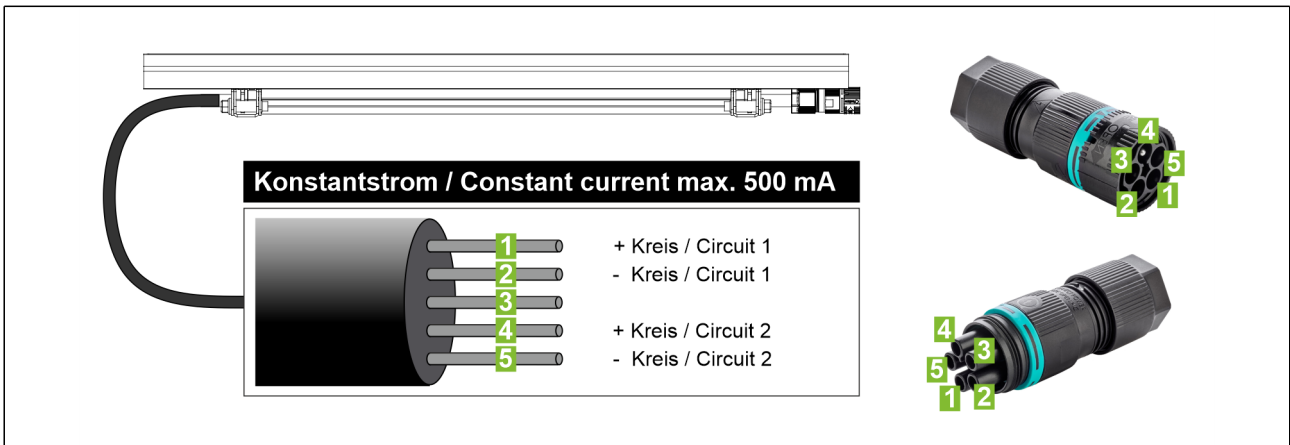

Warning

Disconnect the system from the primary supply voltage before carrying out installation and maintenance work.

Securing against restarting

Wait until all charged components are discharged.
Possibly discharged by short circuit itself.

Failure to do so may result in permanent damage to the fixture!

IMPORTANT NOTICE!

- Never carry out or change the electrical connection under voltage!
- Work only under voltage-free and completely discharged drivers!

The luminaire is **ONLY** designed for operation with a **constant current driver** with max. 500 mA.
Each string must be terminated with an end fixture or an end plug (do not plug under voltage).

Maintenance

Clean device from dirt and residue regularly. Use solvent-free cleaning agents only and do not employ aggressive chemicals or high pressure cleaner. Operate device only after complete drying.

Conformity



Manufacturer



Bion Technologies GmbH

Lindberghstrasse 15

86343 Koenigsbrunn

Tel: +49 (0)8231/95787-0

Fax: +49 (0)8231/95787-29

www.biontechnologies.com

info@biontechnologies.com

YouTube: <http://www.youtube.com/BIONTECHNOLOGIES>

All rights reserved / Subject to change / Specifications may change without notice

BEDIENUNGSANLEITUNG

linea xs hp pureWhite | pureColor

Sicherheitshinweise



Anschluss und Bedienung dieses Geräts sollte ausschließlich von qualifiziertem Fachpersonal in Übereinstimmung mit allen geltenden Vorschriften erfolgen.

Lesen Sie zu Ihrer eigenen Sicherheit sorgfältig alle Hinweise und Montageschritte.
Bewahren Sie die Anleitung für Wartungs- oder Demontearbeiten auf.

Der elektrische Anschluss darf nur von fachkundigem Personal durchgeführt werden, das hierfür ausgebildet und befugt ist.

WARNUNG - Gefahr eines elektrischen Schlages!
Betreiben Sie die Leuchte nur mit einer unbeschädigten Abdeckscheibe.

Die Lichtquelle (LED-Modul) dieser Leuchte ist nicht ersetzbar.

- Wenn die Lichtquelle ihr Lebensdauerende erreicht hat, ersetzen Sie die gesamte Leuchte.
- LED-Modul: Risikogruppe 1



Lieferumfang



- Packen Sie alle Teile aus.
- Prüfen Sie den Verpackungsinhalt auf sichtbare Transportschäden.
- Prüfen Sie, ob der Verpackungsinhalt vollständig ist.





Im Lieferumfang enthalten:

1x Leuchte gem. Spezifikation Produktcode
1x Bedienungsanleitung

Wenn Sie Transportschäden oder Unstimmigkeiten zwischen dem hier angegebenen Lieferumfang und Verpackungsinhalt feststellen, informieren Sie unverzüglich Ihre Verkaufsstelle.

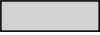
Technische Daten

Abmessungen	46 mm x 57 mm [B x H] 1.80 in x 2.25 in [B x H]														
Leuchtenlängen	324 mm, 477 mm, 629 mm, 782 mm, 934 mm, 1087 mm, 1239 mm 12.76 in, 18.78 in, 24.77 in, 30.79 in, 36.78 in, 42.80 in, 48.78 in														
Leuchtentyp	  pureWhite pureColor														
Farbtemperaturen pureWhite	2200 K, 2700 K, 3000 K, 3500 K, 4000 K * Projektbezogene Farbtemperaturen für pureWhite möglich														
LED-Farben pureColor	Rot, Grün, Blau, Amber * Projektbezogene LED-Farben für pureColor möglich														
Abstrahlwinkel	8°, 10°, 23°, 43°, 8° x 31° 10° x 42°, 12° x 60°, 14° x 100°, 30° x 60°, 60° x 30°														
Lichtstrom	<table border="0"> <tr> <td>324 mm (12.76 in):</td> <td>876 lm</td> </tr> <tr> <td>477 mm (18.78 in):</td> <td>1314 lm</td> </tr> <tr> <td>629 mm (24.77 in):</td> <td>1752 lm</td> </tr> <tr> <td>782 mm (30.79 in):</td> <td>2190 lm</td> </tr> <tr> <td>934 mm (36.78 in):</td> <td>2628 lm</td> </tr> <tr> <td>1087 mm (42.8 in):</td> <td>3066 lm</td> </tr> <tr> <td>1239 mm (48.78 in):</td> <td>3504 lm</td> </tr> </table> pureColor red -> 406 lm/ft pureColor green -> 743 lm/ft pureColor blue -> 329 lm/ft pureColor amber -> 406 lm/ft	324 mm (12.76 in):	876 lm	477 mm (18.78 in):	1314 lm	629 mm (24.77 in):	1752 lm	782 mm (30.79 in):	2190 lm	934 mm (36.78 in):	2628 lm	1087 mm (42.8 in):	3066 lm	1239 mm (48.78 in):	3504 lm
324 mm (12.76 in):	876 lm														
477 mm (18.78 in):	1314 lm														
629 mm (24.77 in):	1752 lm														
782 mm (30.79 in):	2190 lm														
934 mm (36.78 in):	2628 lm														
1087 mm (42.8 in):	3066 lm														
1239 mm (48.78 in):	3504 lm														
Lichtquelle	<table border="0"> <tr> <td>324 mm (12.76 in):</td> <td>8 LEDs</td> </tr> <tr> <td>477 mm (18.78 in):</td> <td>12 LEDs</td> </tr> <tr> <td>629 mm (24.77 in):</td> <td>16 LEDs</td> </tr> <tr> <td>782 mm (30.79 in):</td> <td>20 LEDs</td> </tr> <tr> <td>934 mm (36.78 in):</td> <td>24 LEDs</td> </tr> <tr> <td>1087 mm (42.8 in):</td> <td>28 LEDs</td> </tr> <tr> <td>1239 mm (48.78 in):</td> <td>32 LEDs</td> </tr> </table>	324 mm (12.76 in):	8 LEDs	477 mm (18.78 in):	12 LEDs	629 mm (24.77 in):	16 LEDs	782 mm (30.79 in):	20 LEDs	934 mm (36.78 in):	24 LEDs	1087 mm (42.8 in):	28 LEDs	1239 mm (48.78 in):	32 LEDs
324 mm (12.76 in):	8 LEDs														
477 mm (18.78 in):	12 LEDs														
629 mm (24.77 in):	16 LEDs														
782 mm (30.79 in):	20 LEDs														
934 mm (36.78 in):	24 LEDs														
1087 mm (42.8 in):	28 LEDs														
1239 mm (48.78 in):	32 LEDs														
Farbwiedergabeindex	R _a >= 80														
Entblendung	optional: <ul style="list-style-type: none"> ▪ internes Wabenraster ▪ internes lineares Entblendungsraster 														
LED-Binning															
MacAdam-Ellipsen Binning	3														
Dimmung	Nicht dimmbar Dimmbar (DALI , 0 - 10 V , DMX , EXT)														

Eingangsspannung	Netzteil: extern 36 VDC		
Wirkleistungsaufnahme	324 mm (12.76 in):	Max. 14 W	
	477 mm (18.78 in):	Max. 21 W	
	629 mm (24.77 in):	Max. 28 W	
	782 mm (30.79 in):	Max. 35 W	
	934 mm (36.78 in):	Max. 42 W	
	1087 mm (42.8 in):	Max. 49 W	
	1239 mm (48.78 in):	Max. 56 W	
Schutzklasse	II		
Lagertemperatur	-40 °C / +80 °C -40 °F / +176 °F		
Betriebstemperatur	-40 °C / +40 °C -40 °F / +104 °F		
Einschalttemperatur	-25 °C / +40 °C -13 °F / +104 °F		
Lebensdauer [L70]	65'000 h @ 25 °C (77 °F) 40'000 h @ 40 °C (104 °F)		
Gehäuse	Aluminium-Strangpressprofil		
Gehäusefarbe(n)			
	Aluminium natur eloxiert (Standard)	Schwarz eloxiert	
Linse	Gehärtetes Sicherheitsglas, extra weiß		
Gewicht	324 mm (12.76 in):	1,5 kg (3.31 lbs)	
	629 mm (24.77 in):	2,1 kg (4.63 lbs)	
	934 mm (36.78 in):	3,2 kg (7.05 lbs)	
	1239 mm (48.78 in):	4,4 kg (9.70 lbs)	
Schutzart	IP66		
Umgebung			
	indoor	outdoor	
Schlagschutz	IK08		
Zulassungen			

Technische Zeichnung

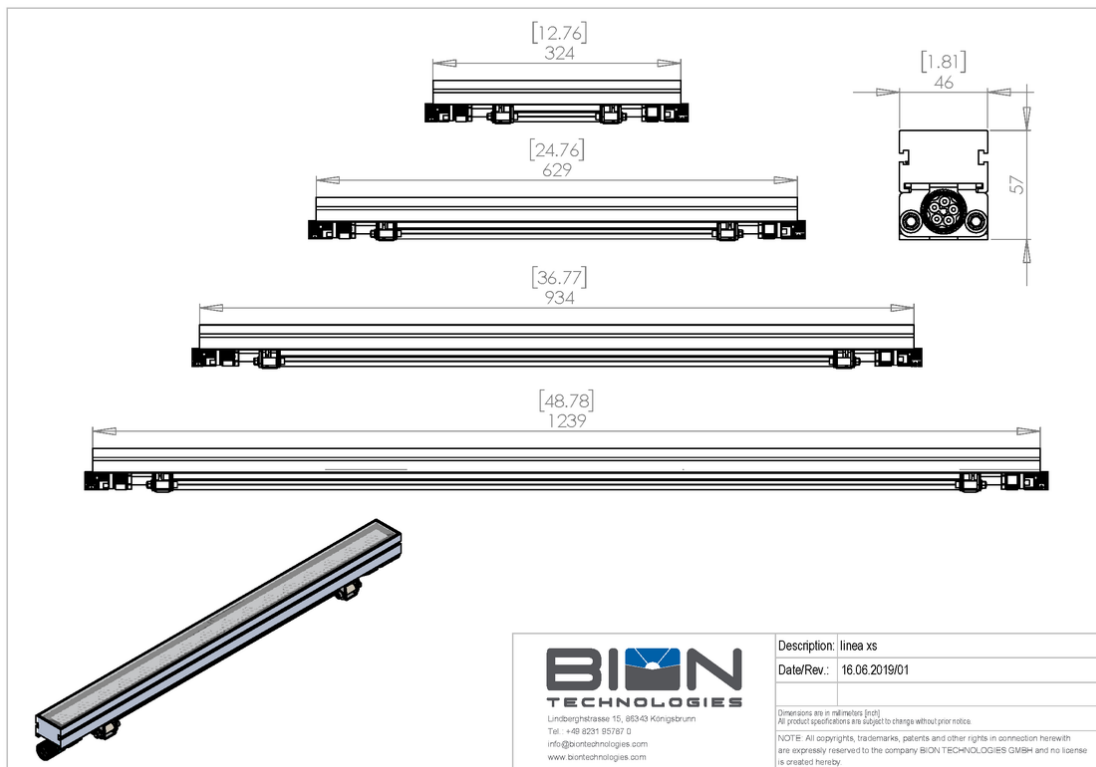

BION
TECHNOLOGIES

Lindberghstrasse 15, 86343 Königsbrunn
Tel.: +49 8231 95787 0
info@biontechnologies.com
www.biontechnologies.com

Description: linea xs

Date/Rev.: 16.06.2019/01

Dimensions are in millimeters [mm]
All product specifications are subject to change without prior notice.

NOTE: All copyrights, trademarks, patents and other rights in connection herewith are expressly reserved to the company BION TECHNOLOGIES GMBH and no license is created hereby.

Inbetriebnahme

1. Elektrischer Anschluss - DALI / DMX / 0-10 V

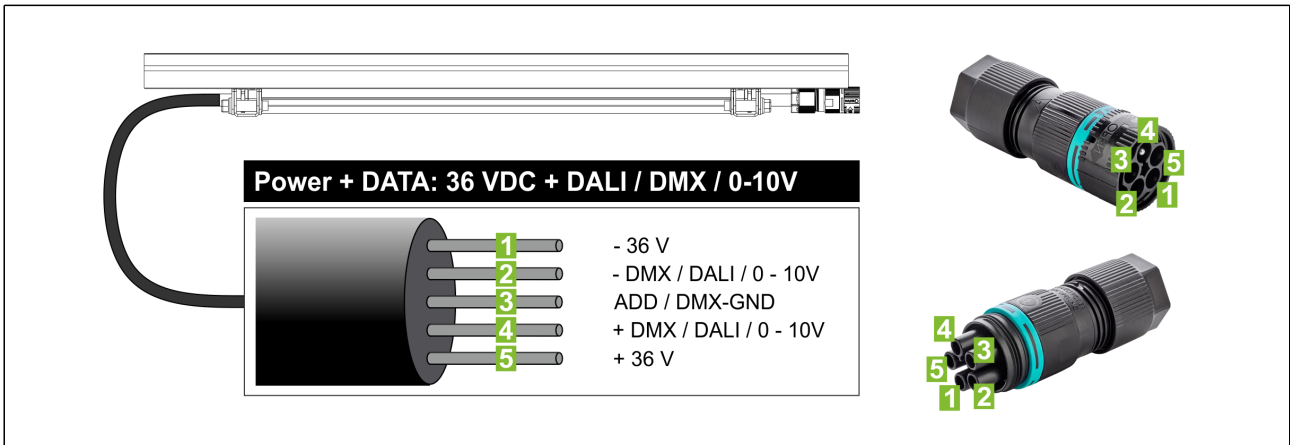

2. Elektrischer Anschluss - EXT (Konstantstrom)

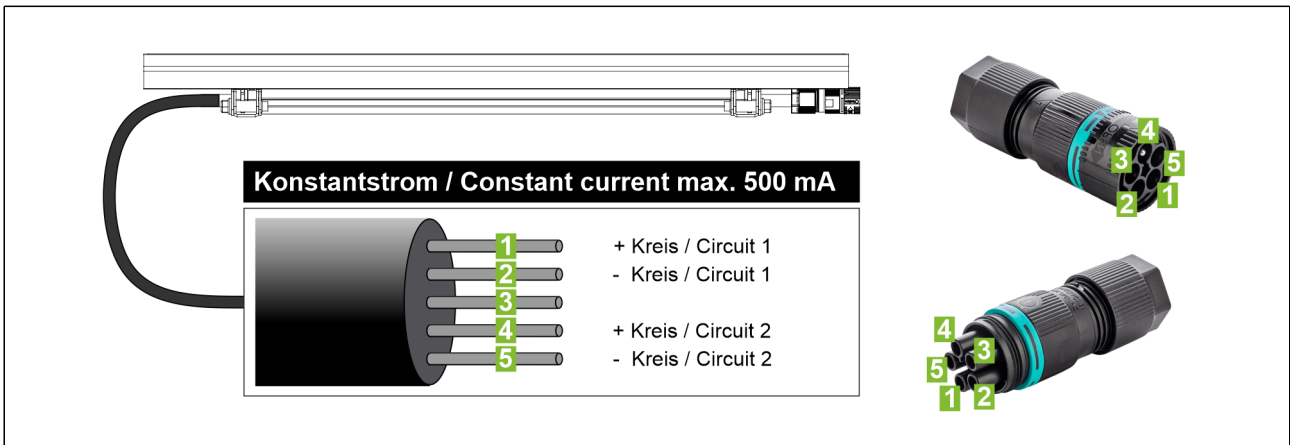

Warnhinweis

Vor Installations- und Wartungsarbeiten das System von der primären Versorgungsspannung trennen.
Sichern gegen Wiedereinschalten
Warten Sie, bis alle elektronischen Bauteile entladen sind.
Eventuell durch Kurzschluss selbst entladen
Bei Nichtbeachtung kann es zu dauerhaften Schäden an der Leuchte kommen!

WICHTIGER HINWEIS!

- Elektrisch Anschluss niemals unter Spannung durchführen oder Verändern!
- Arbeiten nur unter spannungsfreien u. vollständig entladenen Treibern durchführen!

Die Leuchte ist **NUR** für den Betrieb an einem **Konstantstromtreiber** mit max. 500 mA ausgelegt.
Jeder Strang muss mit einer Endleuchte oder einem Endstecker (nicht unter Spannung stecken) abgeschlossen werden.

Wartung + Pflege

Gerät regelmäßig mit einem feuchten Tuch reinigen. Verwenden Sie ausschließlich lösungsmittelfreie Reinigungsmittel und verwenden Sie keine Chemikalien.

Konformität



Hersteller



Bion Technologies GmbH

Lindberghstrasse 15

86343 Koenigsbrunn

Tel: +49 (0)8231/95787-0

Fax: +49 (0)8231/95787-29

www.biontechnologies.com

info@biontechnologies.com

YouTube: <http://www.youtube.com/BIONTECHNOLOGIES>

All rights reserved / Subject to change / Specifications may change without notice



Lindberghstrasse 15
86343 Koenigsbrunn
Tel: +49 (0)8231/95787-0
Fax: +49 (0)8231/95787-29
www.biontechnologies.com
info@biontechnologies.com

YouTube: <http://www.youtube.com/user/BIONTECHNOLOGIES>

© 2022, BION TECHNOLOGIS GMBH
All rights reserved / Subject to change / Specifications may change without notice