



tellus point round xs

RGBW_{quad}





TECHNISCHES DATENBLATT

tellus point round xs

RGBWquad

Technische Daten

Abmessungen	130 mm x 130 mm x 119 mm [L x B x H] 5.12 in x 4.33 in x 4.69 in [L x B x H]
	Höhe inkl. Einbaugehäuse kurz / lang: 200 mm / 290 mm Höhe inkl. Einbaugehäuse kurz / lang: 7.87 in / 11.42 in
Leuchtentyp	 RGBWquad
Farbtemperaturen W-Kanal	3000 K, 4000 K, 6500 K
Abstrahlwinkel	10°, 22°, 34°, 60°, 8° x 31° 10° x 40°, 12° x 60°, 12° x 90°, 30° x 60°, 30° x 58° (Tilt der C0-Ebene: -14°), 30° x 11° (Tilt der C0-Ebene: -14°)
Lichtstrom	311 lm ohne Entblendung
Lichtquelle	1 LED(s)
Farbwiedergabeindex	R _a ≥ 80
Entblendung	Wabenstruktur, Linearraster, kundenspezifische Abschattungen
Steuerung	DMX, IOT, DALI

Eingangsspannung	Netzteil: intern 100 - 240, 277 VAC (50 - 60 Hz) 127 - 431 VDC
Wirkleistungsaufnahme	Max. 12 W
Schutzklasse	I
Lagertemperatur	-40 °C / +80 °C -40 °F / +176 °F
Betriebstemperatur	-40 °C / +40 °C -40 °F / +104 °F
Einschalttemperatur	-25 °C / +40 °C -13 °F / +104 °F
Lebensdauer [L70]	65'000 h @ 25 °C (77 °F) 40'000 h @ 40 °C (104 °F)
LED-Klasse	Klasse 2 LED Produkt
Gehäuse	Aluminiumguss
Gehäusefarbe(n)	Schwarz eloxiert
Linse	Gehärtetes Sicherheitsglas
Rahmen	Edelstahl
Gewicht	1,3 kg (2.9 lbs)
Druckbelastung	500 kg 1100 lbs
Schutzart	IP67
Umgebung	  indoor outdoor
Schlagschutz	IK09
Zulassungen	  

Abstrahlwinkel

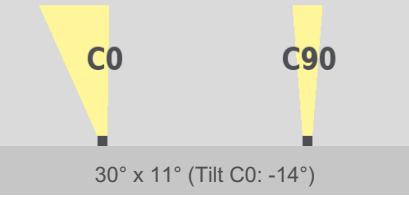
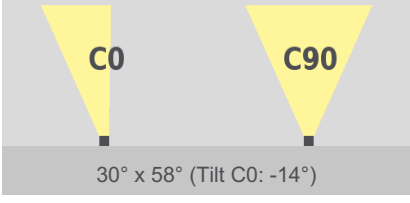
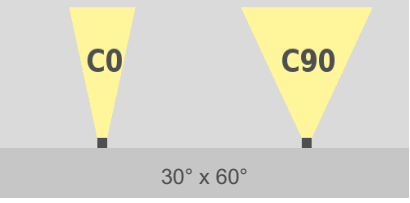
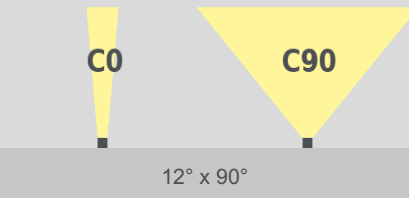
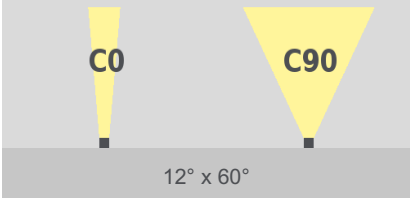
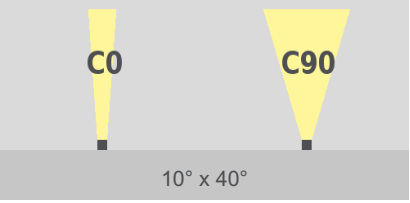
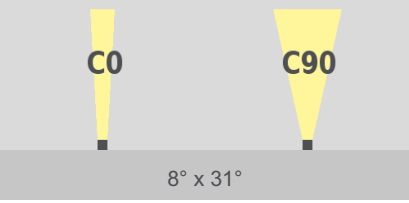
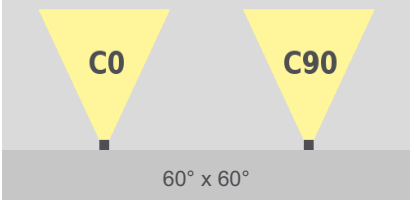
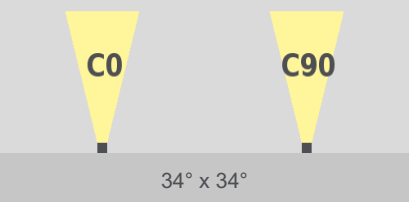
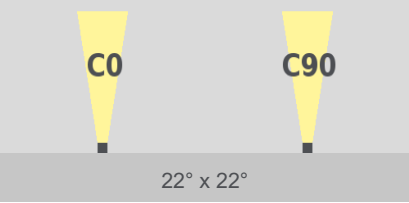
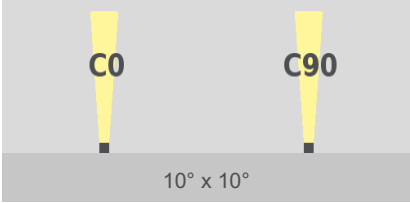

Technische Zeichnung

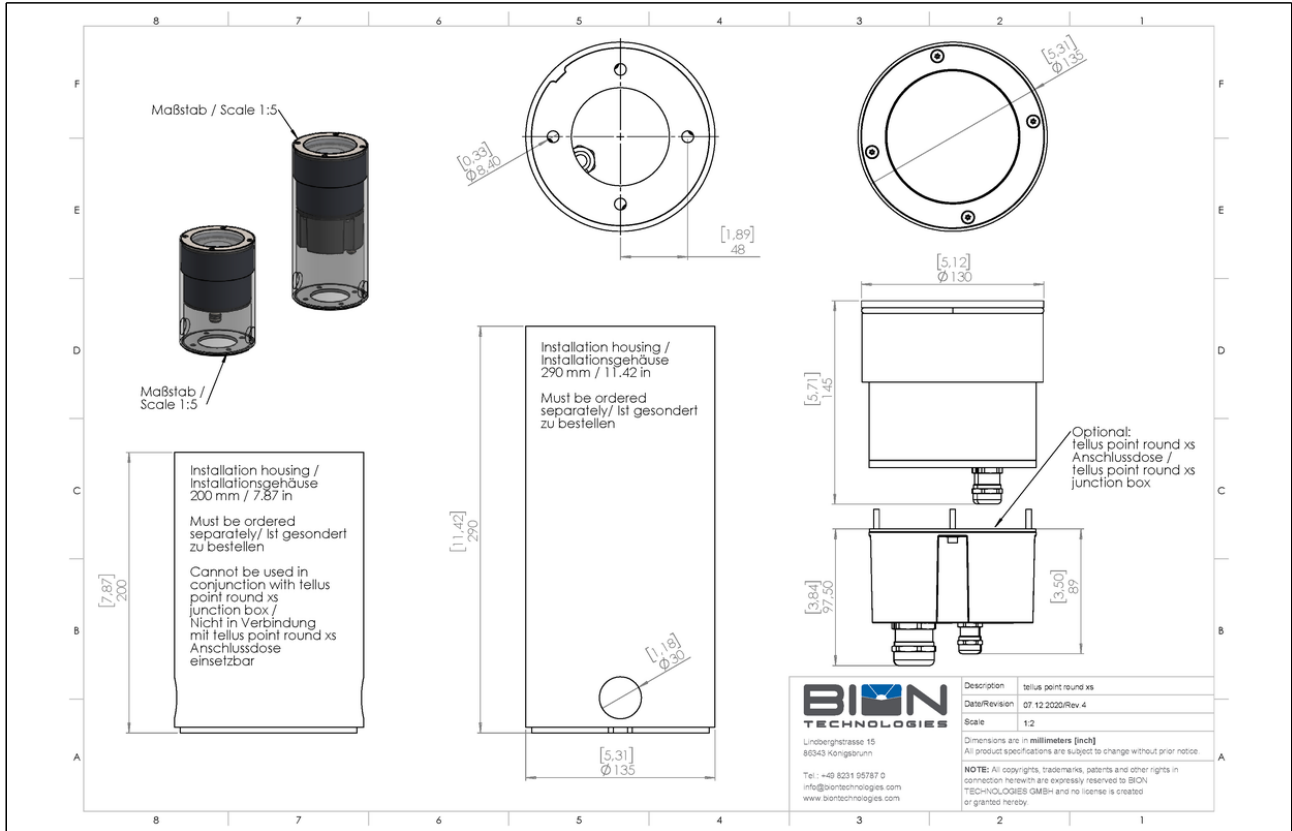

Projekt	Leuchten#	Datum
		Firma



Bestellinformationen

Wählen Sie Ihre Wunschkonfiguration aus und schreiben Sie dann die Kodierung in das entsprechende Feld, um somit die Produktnummer zu erstellen.

TEL-PO-RD-XS- _____ - _____ - _____ - _____ - _____ - Y01

TYP - LICHTFARBE
DIMMUNG
ABSTRAHLUNG
VERKABELUNG
ENTBLENDUNG
ANSCHLUSSLEITUNGSLÄNGE

TYP - LICHTFARBE	
RGBW30	RGBW - 3000 K
RGBW40	RGBW - 4000 K
RGBW65	RGBW - 6500 K

DIMMUNG	
NDIM	Nicht dimmbar
DMX	Dimmbar - DMX
IOT	Dimmbar - IOT
DALI	Dimmbar - DALI

ABSTRAHLUNG	
10X10	10° x 10°
22X22	22° x 22°
34X34	34° x 34°
60X60	60° x 60°
8X31	8° x 31°
10X40	10° x 40°
12X60	12° x 60°
12X90	12° x 90°
30X60	30° x 60°
WWW	30° x 58° (Tilt der C0-Ebene: -14°)
WWN	30° x 11° (Tilt der C0-Ebene: -14°)

VERKABELUNG	
CE	Europa
ETL	Nord Amerika

ENTBLENDUNG	
OP	Keine Entblendung
HL	Wabenraster
LL17	Linearraster 17°
LL00	Linearraster 0°
CGC	kundenspezifische Entblendung
LL17 nur in Verbindung mit Abstrahlwinkel WWW oder WWN	

ANSCHLUSSLEITUNGSLÄNGE	
1M	1 m (3.3 ft)
3M	3 m (10 ft)
6M	6 m (19.7 ft)
9M	9 m (29.5 ft)
15M	15 m (49.2 ft)

Beispiel Produktnummer: TEL-PO-RD-XS-PW27-DMX-34X34-ETL-OP-Y01

* Projektbezogene Optionen sind verfügbar - Bitte kontaktieren Sie Ihren Ansprechpartner für weitere Informationen.



Lindberghstrasse 15
86343 Koenigsbrunn
Tel: +49 (0)8231/95787-0
Fax: +49 (0)8231/95787-29
www.biontechnologies.com
info@biontechnologies.com

YouTube: <http://www.youtube.com/user/BIONTECHNOLOGIES>

© 2023, BION TECHNOLOGIS GMBH
All rights reserved / Subject to change / Specifications may change without notice