



**linea xs mp**  
tunableWhite





TECHNICAL DATASHEET

# linea xs mp

## tunableWhite

### Technical Data

Dimensions	46 mm x 57 mm [W x H] 1.80 in x 2.25 in [W x H]
Standard Unit Lengths	324 mm, 477 mm, 629 mm, 782 mm, 934 mm, 1087 mm, 1239 mm 12.76 in, 18.78 in, 24.77 in, 30.79 in, 36.78 in, 42.80 in, 48.78 in
Fixture Typ	 tunableWhite
Color Temperatures tunableWhite	2200 K - 4000 K * Project-specific color temperature ranges for tunableWhite available.
Beam Angles	8°, 10°, 23°, 43°, 8° x 31° 10° x 42°, 12° x 60°, 14° x 100°, 30° x 60°, 60° x 30°
Light Source	324 mm (12.76 in): 8 LEDs 477 mm (18.78 in): 12 LEDs 629 mm (24.77 in): 16 LEDs 782 mm (30.79 in): 20 LEDs 934 mm (36.78 in): 24 LEDs 1087 mm (42.8 in): 28 LEDs 1239 mm (48.78 in): 32 LEDs
Antiglare	optional: <ul style="list-style-type: none"><li>▪ Hex louver (internal)</li><li>▪ Linear louver (internal)</li></ul>
LED-Binning	
MacAdam Ellipses Binning	3
Control	DALI, DMX

Input Voltage	Power supply: external   36 VDC		
Power Consumption	324 mm (12.76 in):	Max. 10 W	
	477 mm (18.78 in):	Max. 15 W	
	629 mm (24.77 in):	Max. 20 W	
	782 mm (30.79 in):	Max. 25 W	
	934 mm (36.78 in):	Max. 30 W	
	1087 mm (42.8 in):	Max. 35 W	
	1239 mm (48.78 in):	Max. 40 W	
Protection Class	II		
Storage Temperatur	-40 °C / +80 °C   -40 °F / +176 °F		
Operating Temperature	-40 °C / +40 °C   -40 °F / +104 °F		
Start-up Temperature	-25 °C / +40 °C   -13 °F / +104 °F		
Lumen Maintenance [L70]	65'000 h @ 25 °C (77 °F)   40'000 h @ 40 °C (104 °F)		
Housing	Aluminum extruded profile		
Housing Color(s)			
	Aluminium anodized (Standard)	Black anodized	
Lens	Tempered safety glass, extra white		
Weight	324 mm (12.76 in):	1,5 kg (3.31 lbs)	
	629 mm (24.77 in):	2,1 kg (4.63 lbs)	
	934 mm (36.78 in):	3,2 kg (7.05 lbs)	
	1239 mm (48.78 in):	4,4 kg (9.70 lbs)	
Ingress Protection	IP66		
Environment			
	indoor	outdoor	
Impact Protection	IK08		
Certification			

## Beam Angles

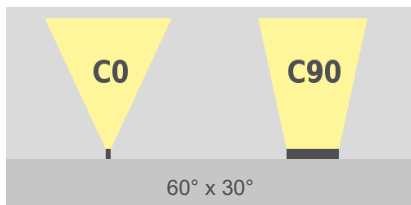
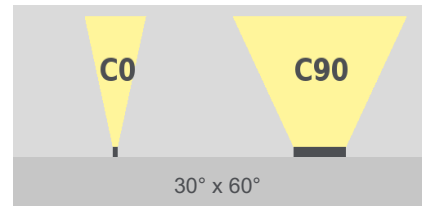
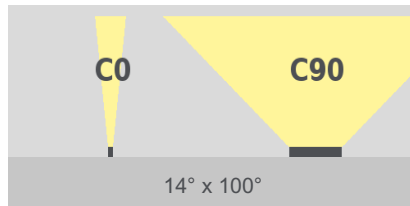
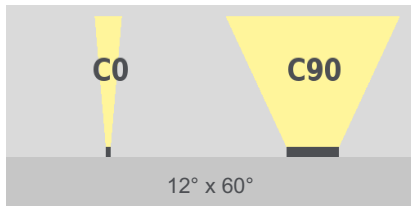
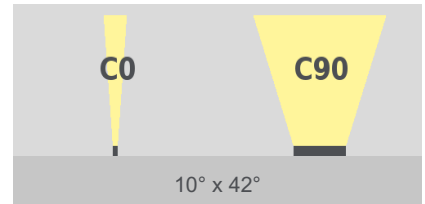
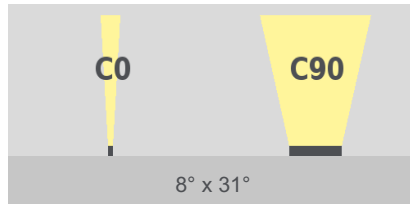
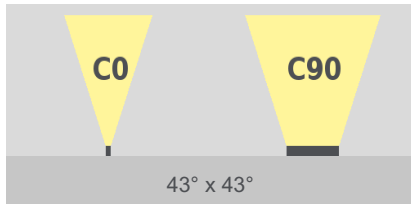
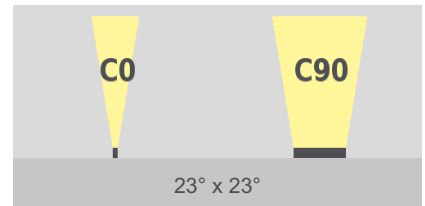
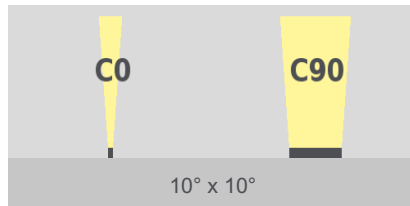
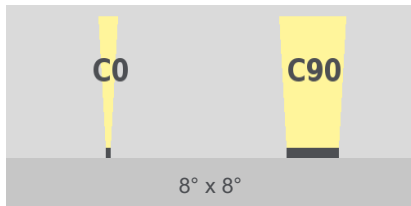

# Engineering Drawing

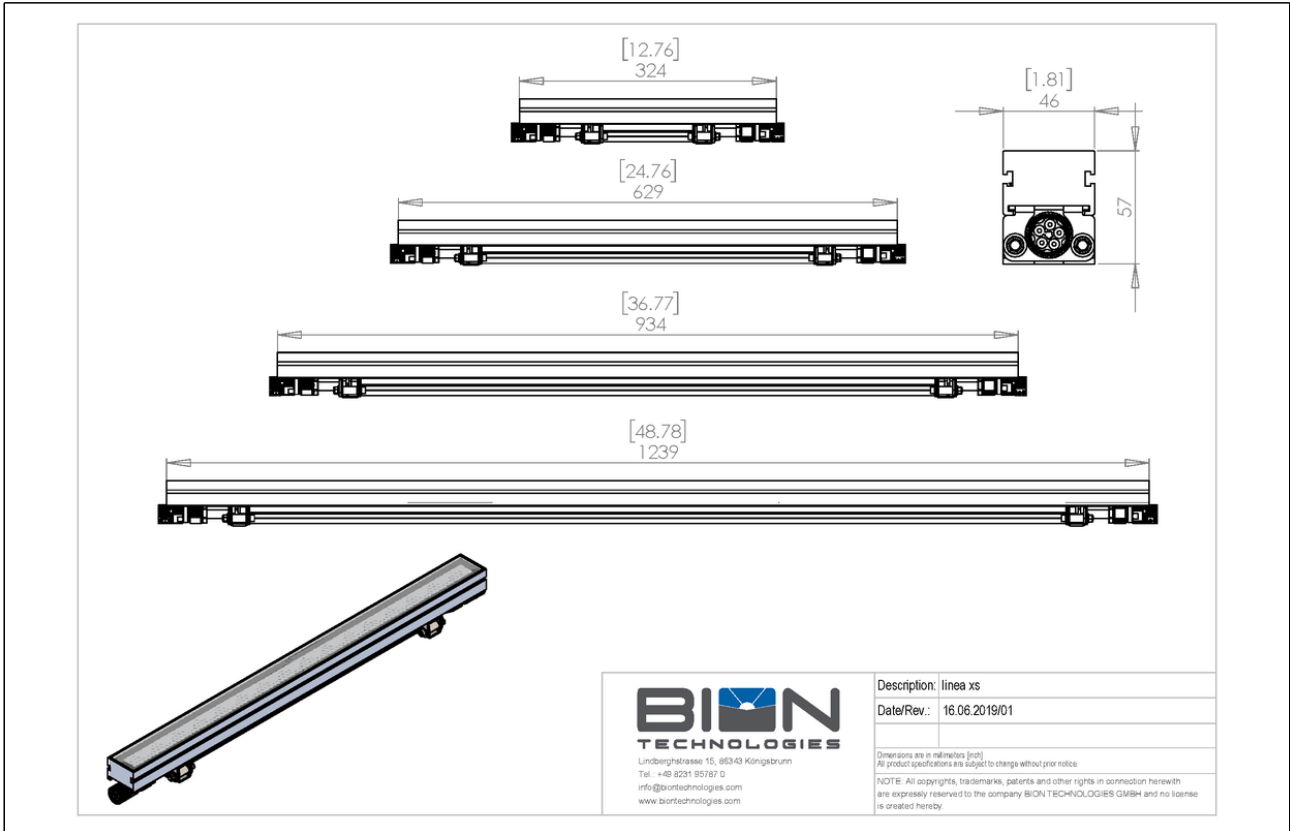

<b>Project</b>	<b>Fixture#</b>	<b>Date</b>
		<b>Firm</b>



## Ordering Information

Choose the option that suits your needs and write its corresponding code on the appropriate line to form the product code.

LIN-XS-MP- TW2240 - - - - - Y01

TYP - LUMINOUS COLOR	DIMMING	FIXTURE LENGTH	BEAM ANGLE	HOUSING COLOR	GLARE PROTECTION	WIRING CONFIGURATION	LEADERCABLE LENGTH	MOUNTING OPTION
<b>TYP - LUMINOUS COLOR</b>								
TW2240 tunableWhite - 2200 K - 4000 K								
<b>DIMMING</b>								
DALI Dimmable - DALI								
DMX Dimmable - DMX								
<b>FIXTURE LENGTH</b>								
324 324 mm / 12.76 in								
477 477 mm / 18.78 in								
629 629 mm / 24.76 in								
782 782 mm / 30.79 in								
934 934 mm / 36.77 in								
1087 1087 mm / 42.8 in								
1239 1239 mm / 48.78 in								
	<b>BEAM ANGLE</b>							
	8X8 8° x 8°							
	10X10 10° x 10°							
	23X23 23° x 23°							
	43X43 43° x 43°							
	8X31 8° x 31°							
	10X42 10° x 42°							
	12X60 12° x 60°							
	14X100 14° x 100°							
	30X60 30° x 60°							
	60X30 60° x 30°							
	<b>HOUSING COLOR</b>							
	AA Aluminium anodized (Standard)							
	BA Black anodized							
	<b>GLARE PROTECTION</b>							
	OP No glare protection							
	HL Hex louver (internal)							
	LL0 Linear louver (internal)							
		<b>WIRING CONFIGURATION</b>						
		IOCC IN/OUT with Connector						
		IXCX only IN with Connector						
		IOOC IN open end / OUT socket						
		IOOO IN/OUT with open ends						
		IXOX only IN with open ends						
		<b>LEADERCABLE LENGTH</b>						
		ETE End to end - wiring						
		003 + 30 cm (ca. 1 ft)						
		006 + 60 cm (ca. 2 ft)						
		009 + 90 cm (ca. 3 ft)						
		012 + 1,2 m (ca. 4 ft)						
		<b>MOUNTING OPTION</b>						
		ND without bracket						
		BS Universal mounting bracket						

\* Project-specific options are available - Please contact our Sales Representative for further information.



Lindberghstrasse 15  
86343 Koenigsbrunn  
Tel: +49 (0)8231/95787-0  
Fax: +49 (0)8231/95787-29  
[www.biontechnologies.com](http://www.biontechnologies.com)  
[info@biontechnologies.com](mailto:info@biontechnologies.com)

YouTube: <http://www.youtube.com/user/BIONTECHNOLOGIES>

© 2024, BION TECHNOLOGIS GMBH  
All rights reserved / Subject to change / Specifications may change without notice